

Rollen- und Gliederketten Roller and link chains

duebre[®]
we move water...

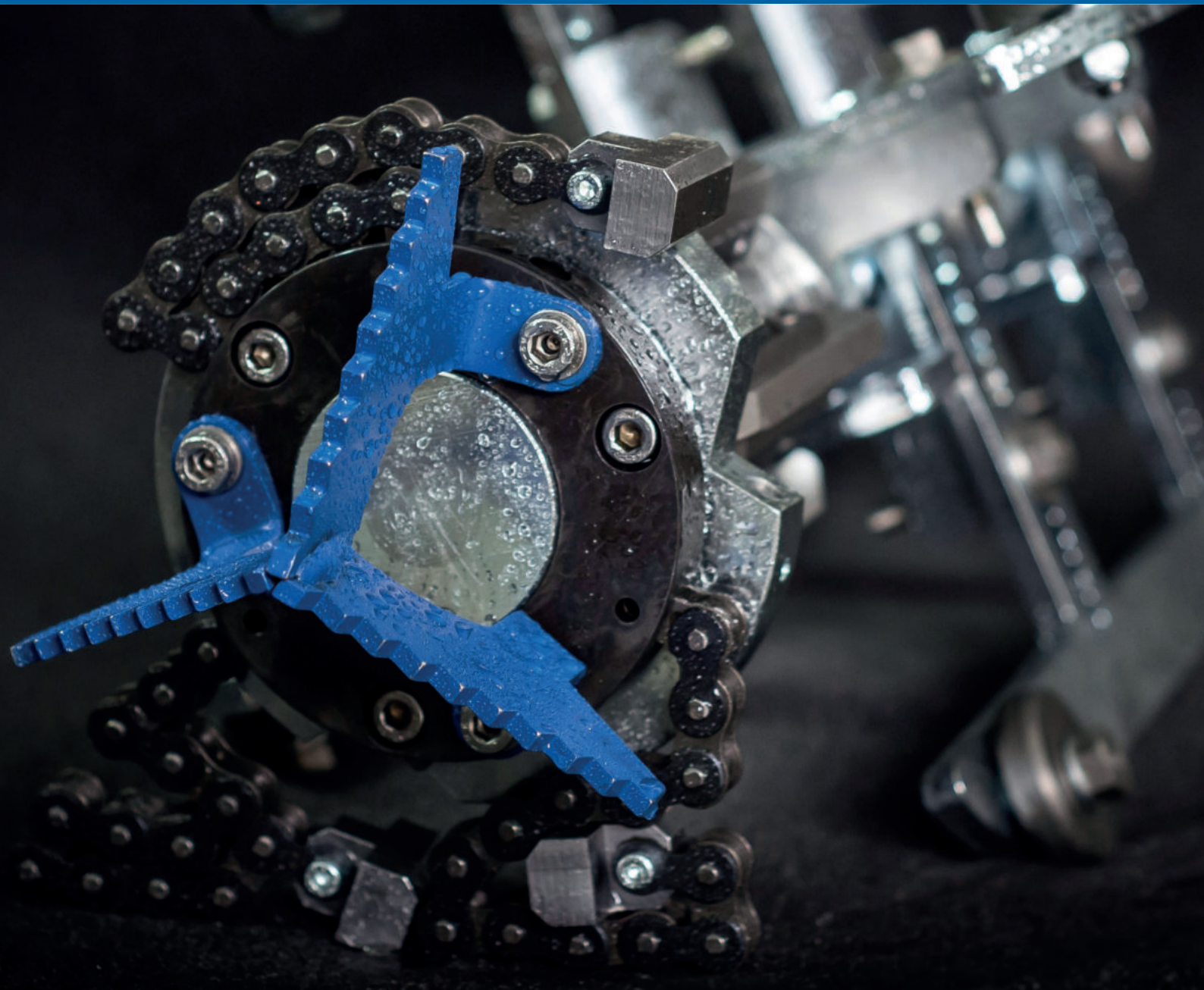

Wie setzt sich die Artikelnummer der Ketten zusammen? What is the composition of the article number of the chains?

9051-0000

Die ersten vier Stellen geben die Kettenart an.
The first four digits indicate the type of chain.

-0000 steht für Meterware.
-0000 stands for meter ware.

9051-0304

Die erste Stelle gibt die Ausführung an.
The first digit indicates the execution.

0 geschlossen-offen / closed-open



1 geschlossen-Endstück klein /
closed-end piece small



2 Glied Endstück / link end piece



5 offen-offen / open-open



9 geschlossen-Hammer / closed-hammer



B großer Hammer / big hammer





Die zweite Stelle gibt die Anzahl
der Ketten im Set an.
The second digit indicates the
number of chains in a set.

Die dritte und vierte Stelle gibt
die Anzahl der Stifte/ Glieder an.
The third and fourth digit indica-
tes the number of pins/ links.

Ketten- und Gliederarten Chain- and link types

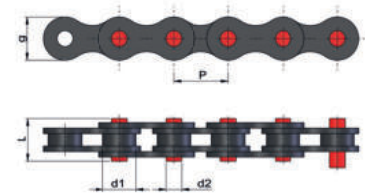
Rollenketten Roller chains



	Kettengröße Chain size	Teilung p pitch p	Bolzenlänge L pin length L	Rollen-Ø d1 roller-Ø d1	Bolzen-Ø d2 pin-Ø d2	Laschenhöhe g plate depth g	kg/m
9050-0000	½"	12.7 mm	11.5 mm	8.0 mm	4.0 mm	10.0 mm	0.4
9051-0000	⅝"	15.9 mm	19.6 mm	10.2 mm	5.1 mm	14.7 mm	0.9
9052-0000	¾" LD (leichte Beanspruchung/ light duty)	19.0 mm	22.7 mm	12.0 mm	5.7 mm	15.0 mm	1.9
9053-0000	¾" HD (hochbelastbar/ heavy duty)	19.0 mm	26.0 mm	12.0 mm	6.0 mm	18.0 mm	2.3
9054-0000	1"	25.4 mm	36.1 mm	15.88 mm	8.28 mm	21.0 mm	2.5



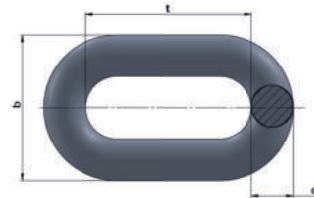

Gliederketten Link chains





	Nennstärke d Chain size	Teilung t pitch t	Breite b wide b	kg/m	Material Material	Bruchkraft kN tensile strength kN
5050-0000	4.0 mm	13.0 mm	13.5 mm	0.5	gehärteter Stahl hardened steel	0.6
5051-0000	5.5 mm	18.3 mm	19.0 mm	1.0	gehärteter Stahl hardened steel	1.0
5052-0000	7.0 mm	24.3 mm	25.0 mm	1.3	gehärteter Stahl hardened steel	1.4
5053-0000	4.0 mm	16.0 mm	14.0 mm	0.5	gehärteter Stahl hardened steel	0.6
5054-0000	8.0 mm	28.0 mm	29.0 mm	4.2	gehärteter Stahl hardened steel	6.0

Blue100 SPIDER HD

Mögliches Zubehör Possible accessories

	RohrØ mm pipeØ Inch	250 (10)	300 (12)	350 (14)	400 (16)	450 (18)	500 (20)	550 (22)	600 (24)	650 (26)	700 (28)	750 (29)
Kettentyp chain type												
Rollenkette mit Hammer ¾", Set 3 Stk. Roller chain with hammer ¾", set 3 pcs.		9052-9312										
Rollenkette offen ¾", Set 3 Stk. Roller chain open ¾", set 3 pcs.		9052-0312										
Rollenkette mit Hammer ¾" HD, Set 3 Stk. Roller chain with hammer ¾" HD, set 3 pcs.		9053-9312										
Rollenkette offen ¾" HD, Set 3 Stk. Roller chain open ¾" HD, set 3 pcs.		9053-0312										



Ersatzteile spare parts		
Endstück, 1 Stk. End piece, 1 pc.		9052-9000 9053-9000



8000-SH04

Blue100 SPIDER HD

Mögliches Zubehör Possible accessories

RohrØ mm pipeØ Inch	150 (6)	200 (8)	250 (10)	300 (12)	350 (14)	400 (16)	450 (18)	500 (20)	550 (22)	600 (24)	650 (26)	700 (28)	750 (29)
Kettentyp chain type													
Rollenkette mit großer Hammer 1", Set 3 Stk. Roller chain with big hammer 1", set 3 pcs. 	X	9054-B302	9054-B303	9054-B304	9054-B305	9054-B306	9054-B307	9054-B308	9054-B309	9054-B310	9054-B311	9054-B312	9054-B313
Kann nur mit 8000-2071 Kettenaufnahme eingesetzt werden / can only be used with 8000-2071 chain receptacle													
Rollenkette offen 1", Set 3 Stk. Roller chain open 1", set 3 pcs. 	9054-0303	9054-0304	9054-0305	9054-0306	9054-0307	9054-0308	9054-0309	9054-0310	9054-0311	9054-0312	9054-0313	9054-0314	9054-0315
Kann nur mit 8000-2071 Kettenaufnahme eingesetzt werden / can only be used with 8000-2071 chain receptacle													





Zubehör / Ersatzteile accessories / spare parts	
Kettenaufnahme 1" Chain receptacle 1"	8000-2071
Kettendeckel 1" inkl. Schrauben Chain cover 1" incl. screws	8000-3071
*Kettenhalter mit Spirale und Ketten 9054-0308, Set 3 Stk. *Chain holder with spiral and chains 9054-0308, set 3 pcs.	8000-2098
*Spirale 1" *Spiral 1"	8000-2099
*Kettenhalter 1" *Chain holder 1"	8000-2101
Endstück großer Hammer, 1 Stk. End piece big hammer, 1 pc.	9054-B000



* nicht erhältlich für Rohrdurchmesser von 200 bis 400 mm
* not available for pipe diameters from 200 to 400 mm

Blue100 SPIDER

Mögliches Zubehör Possible accessories

	RohrØ mm pipeØ Inch	250 (10)	300 (12)	350 (14)	400 (16)	450 (18)	500 (20)	550 (22)	600 (24)	700 (28)	800 (31)	900 (35)
Kettentyp chain type												
Rollenkette mit Hammer 5/8", Set 3 Stk. Roller chain with hammer 5/8", set 3 pcs.		9051-9303	9051-9305	9051-9307	9051-9309	9051-9311	9051-9313	9051-9315	9051-9317	9051-9321	9051-9325	9051-9329
Rollenkette offen 5/8", Set 3 Stk. Roller chain open 5/8", set 3 pcs.		9051-0303	9051-0305	9051-0307	9051-0309	9051-9311	9051-0313	9051-0315	9051-0317	9051-0321	9051-0325	9051-0329
Rollenkette mit Endstück klein 5/8", Set 3 Stk. Roller chain with end piece small 5/8", set 3 pcs.		9051-1303	9051-1305	9051-1307	9051-1309	9051-1311	9051-1313	9051-1315	9051-1317	9051-1321	9051-1325	9051-1329
Gliederkette, Set 3 Stk. Link chain, set 3 pcs		X	X	X	5052-0309	X	5052-0313	X	5052-0317	5052-0321	X	X

Ersatzteile spare parts	
Endstück klein, 1 Stk. End piece small, 1 pc.	 9051-1000
Endstück, 1 Stk. End piece, 1 pc.	 9051-9000

Mögliches Zubehör Possible accessories

	RohrØ mm pipeØ Inch	200 (8)	250 (10)	300 (12)	350 (14)	375 (15)	400 (16)	450 (18)	500 (20)	525 (21)
Kettentyp chain type										

3000-0200E T-Spider

Rollenkette mit großer
Hammer 1", Set 3 Stk.
Roller chain with big
hammer 1", set 3 pcs.



9054-B302	9054-B303	9054-B304	9054-B305	X	9054-B306	X	X	X
-----------	-----------	-----------	-----------	---	-----------	---	---	---

Gliederkette, Set 3 Stk.
Link chain, set 3 pcs.



5051-0305	5051-0307	5051-0309	5051-0311	X	5051-0313	X	X	X
-----------	-----------	-----------	-----------	---	-----------	---	---	---

3000-0200 T-Spider

Gliederkette, Set 3 Stk.
Link chain, set 3 pcs.



5054-0302	5054-0302	5054-2303	X	5054-2305	5054-0306	5054-0306	5054-2307	5054-2307
-----------	-----------	-----------	---	-----------	-----------	-----------	-----------	-----------



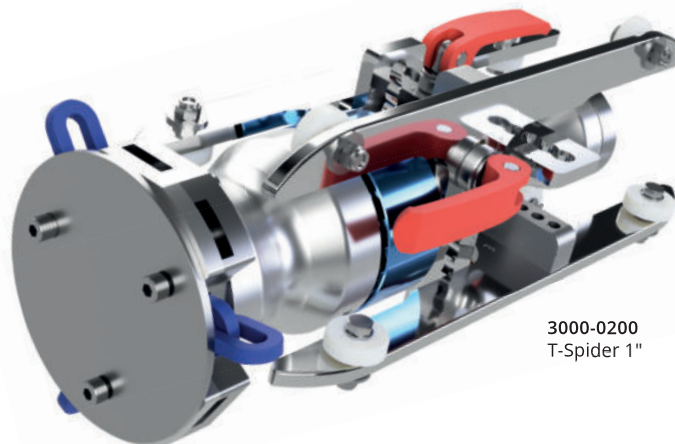

3000-0200E
T-Spider 1"



3000-0200
T-Spider 1"

Mögliches Zubehör Possible accessories

	RohrØ mm pipeØ Inch	80 (3.2)	100 (4)	125 (5)	150 (6)
Kettentyp chain type					
Rollenkette offen 5/8", Set 3 Stk. Roller chain open 5/8", set 3 pcs.		9051-0303	9051-0303	9051-0303	9051-0304
Rollenkette mit Endstück klein 5/8", Set 3 Stk. Roller chain with end piece small 5/8", set 3 pcs.		9051-1303	9051-1303	9051-1303	9051-1304
Gliederkette, Set 3 Stk. Link chain, set 3 pcs.		5050-0305	5050-0305	5050-0307	5050-0309

Ersatzteile spare parts		
Endstück klein, 1 Stk. End piece small, 1 pc.		9051-1000



2950-0100
Spider50 1/2"
mit Rollenketten, ohne Endstücken
with roller chains, without end pieces

2950-1100
Spider50 1/2"
mit Rollenketten und Endstücken
with roller chains and end pieces



2950-9900
Spider50 1/2"
mit Gliederketten
with link chains

Mögliches Zubehör Possible accessories

	RohrØ mm pipeØ Inch	100 (4)	125 (5)	150 (6)	200 (8)
Kettentyp chain type					
Spider70					
Rollenkette offen ½", Set 3 Stk. Roller chain open ½", set 3 pcs.		X	9051-0303	9051-0305	9051-0309
Rollenkette mit End- stück klein ½", Set 3 Stk. Roller chain with end piece small ½", set 3 pcs.		X	9051-1303	9051-1305	9051-1309
Gliederkette, Set 3 Stk. Link chain, set 3 pcs.		X	5050-0305	5050-0307	5050-0311
Spider Speedo					
Rollenkette offen ½", Set 3 Stk. Roller chain open ½", set 3 pcs.		9050-0207	9050-0209	9050-0211	9050-0215

Ersatzteile spare parts	
Endstück klein, 1 Stk. End piece small, 1 pc.	
	9051-1000



2970-0100
Spider70 1"
mit Rollenketten, ohne Endstücken
with roller chains, without end pieces

2970-1100
Spider70 1"
mit Rollenketten und Endstücken
with roller chains and end pieces



2970-0000
Spider70 1"
mit Gliederketten
with link chains





3502-0000
Spider Speedo ½"
inkl. Führungskörbe und Rollenketten
incl. centralizer cage and roller chains

SPIDER60 | SPIDER6080 | SPIDER80



Mögliches Zubehör Possible accessories

	RohrØ mm pipeØ Inch	100 (4)	125 (5)	150 (6)	200 (8)	250 (10)	300 (12)
Kettentyp chain type							
Spider60							
Gliederkette, Set 3 Stk. Link chain, set 3 pcs.		5051-0305	5051-0307	5051-0307	X	X	X
Spider6080							
Gliederkette, Set 3 Stk. Link chain, set 3 pcs.		X	X	5051-0307	5051-0311	5051-0313	X
Spider80							
Gliederkette, Set 3 Stk. Link chain, set 3 pcs.		X	X	5051-0307	5051-0311	5051-0313	5051-0317



3505-0000
Spider60 ½"
3508-0000
Spider60 ¾"

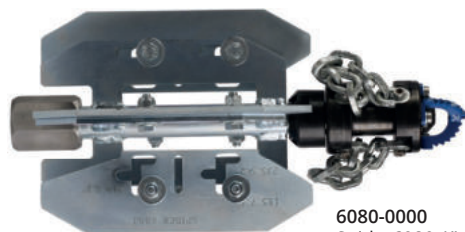







6080-0000
Spider6080 1"



3511-0000
Spider80 1"

Mögliches Zubehör Possible accessories

	RohrØ pipeØ	250 (10)	300 (12)	350 (14)	400 (16)	500 (20)	600 (24)	700 (28)	800 (31)	900 (35)
Kettentyp chain type										
Spider250						Spider450				
Rollenkette mit Hammer 5/8", Set 3 Stk. Roller chain with hammer 5/8", set 3 pcs.		9051-9303	9051-9305	9051-9307	9051-9309	9051-9308	9051-9312	9051-9316	9051-9320	9051-9324
Rollenkette offen 5/8", Set 3 Stk. Roller chain open 5/8", set 3 pcs.		9051-0305	9051-0307	X	9051-0311	9051-0309	9051-0313	9051-0315	9051-0319	9051-0321
Rollenkette mit Endstück klein 5/8", Set 3 Stk. Roller chain with end piece small 5/8", set 3 pcs.		9051-1304	9051-1306	X	9051-1310	9051-1308	9051-1312	9051-1316	9051-1318	9051-1321
Gliederkette, Set 3 Stk. Link chain, set 3 pcs.		X	5052-0311	X	5052-0313	5052-0308	5052-0310	5052-0312	5052-0314	5052-0316

Ersatzteile spare parts	
Endstück klein, 1 Stk. End piece small, 1 pc.	 9051-1000
Endstück, 1 Stk. End piece, 1 pc.	 9051-9000



3514-0000
Spider250 1"



3520-0000
Spider450 1"



Brendle GmbH & Co. KG
Herdternstr. 4
D-72581 Dettingen/Erms
Tel: +49 (0)7123 / 96298-0
Fax: +49 (0)7123 / 96298-10

www.duebre.com
Email: sales@duebre.com

Katalog Rollen- und Gliederketten
Catalog Roller and link chains

Bestell-Nr. / ordner-no. #0001-0040



0001-0000



0001-0140

Bitte beachten Sie unsere allgemeinen Geschäftsbedingungen. Auf Anfrage senden wir Ihnen diese unverbindlich zu. Für den nicht ordnungsgemäßen Einsatz der Düsen und Werkzeuge übernimmt die Fa. Brendle GmbH & Co. KG keine Haftung. Produktänderungen sind der Fa. Brendle GmbH & Co. KG vorbehalten. Sämtliche Inhalte, Fotos, Texte und Grafiken sind urheberrechtlich geschützt. Sie dürfen ohne vorherige Genehmigung weder ganz noch auszugsweise kopiert, verändert, vervielfältigt oder veröffentlicht werden.

Please note our general terms and conditions. On request we will send you this without obligation. Brendle GmbH & Co. KG will not accept liability for the improper use of the nozzles and tools. Product changes are reserved for Brendle GmbH & Co. KG. All contents, photos, texts and graphic arts are protected by copyright. They may not be copied, altered, reproduced or published without prior authorization.